



- Possui LED de indicação de operação
 - Grau de proteção IP65
 - Ajuste de distância sensora
 - Saída relé 5A - 1NA
 - Com função de temporização
- LED operation indicator
 - IP65 protection degree
 - Sensing distance adjustment
 - 5A NO relay output
 - With delay function

Código de compra / How to order

PKD-50-RT - Difuso / Diffuse
 PKR-5M-RT - Retrorefletivo / Retroreflective
 PKB-10M-RT - Barreira / Through-beam



Especificações / Specifications

Modelo / Type	PKD-50-RT	PKR-5M-RT	PKB-10M-RT
			
	Difuso / Diffuse	Retrorefletivo / Retroreflective	Barreira / Through-beam
Distância sensora / Sensing distance	50cm	5m	10m
Alimentação / Power supply	90 ~ 260VCA / VAC 20 ~ 30VCC / VDC		
Fonte de luz / Light source	Infra-vermelho / Infrared 850 nm		
Saída / Output	Relé com 1 contato NA 5A@125VCA / 30VCC / N.O. relay 5A@125VAC / 30VDC		
Sensibilidade / Sensitivity	Ajustável / Adjustable		
Indicação / Indication	LEDs indicadores de alimentação e operação / Indicator LEDs for operation and power		
Consumo máximo / Maximum consumption	25mA		
Tempo de resposta / Response time	20ms ou menos / 20ms or less		
Conexão / Connection	Cabo 2m (Ø4,2mm) / 2m cable (Ø4,2mm)		
Temperatura ambiente / Ambient temperature	-20 ~ 60°C		
Umidade ambiente / Ambient humidity	35 ~ 85% RH		
Peso / Weight	85g		
Grau de proteção / Protection degree	IP65		
Função temporização / Timer function	Atraso no desligamento 0,2s / 0,2s off delay		

Esquema de ligação / Wiring

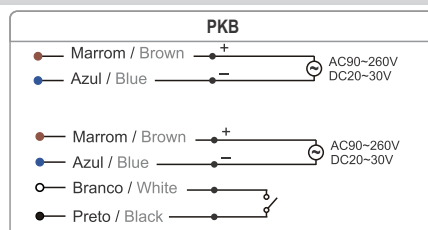
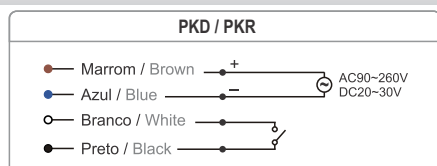

Dimensões / Dimensions (mm)

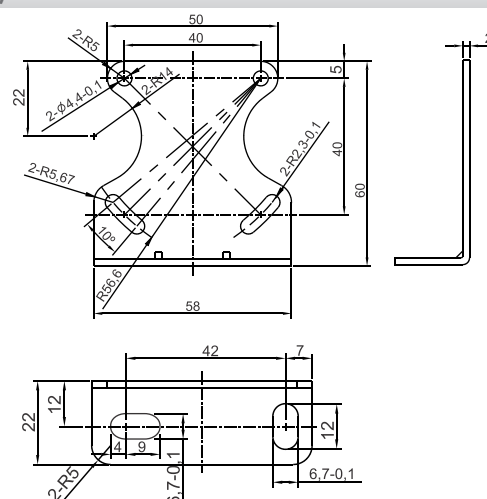
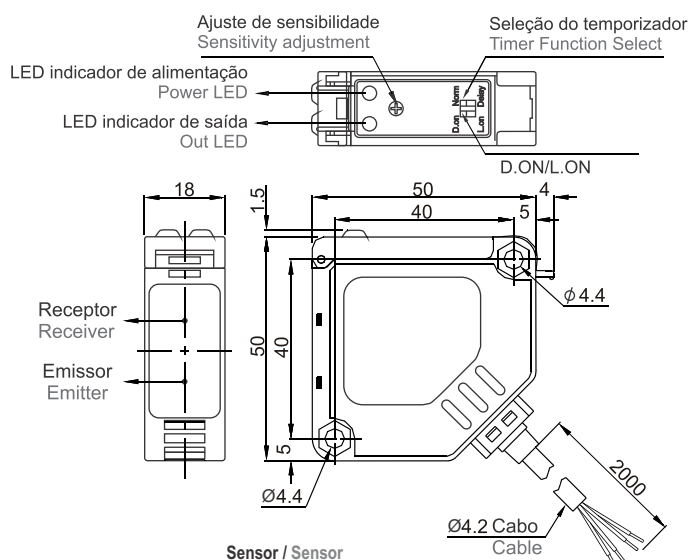

Suporte de montagem / Mounting suport